

# Fuel Cell and Battery Electric Vehicles Compared

By C. E. (Sandy) Thomas, Ph.D., President  
H<sub>2</sub>Gen Innovations, Inc.  
Alexandria, Virginia  
[Thomas@h2gen.com](mailto:Thomas@h2gen.com)

## 1.0 Introduction

Detailed computer simulations demonstrate that all-electric vehicles will be required to meet our energy security and climate change reduction goals<sup>1</sup>. As shown in Figure 1, hybrid electric vehicles (HEV's) and plug-in hybrid electric vehicles (PHEV's) both reduce greenhouse gas (GHG) emissions, but neither of these vehicles that still use internal combustion engines will be adequate to cut GHGs to 80% below 1990 levels, the goal set by the climate change community, even if biofuels such as cellulosic ethanol are used in place of gasoline to power the internal combustion engines.

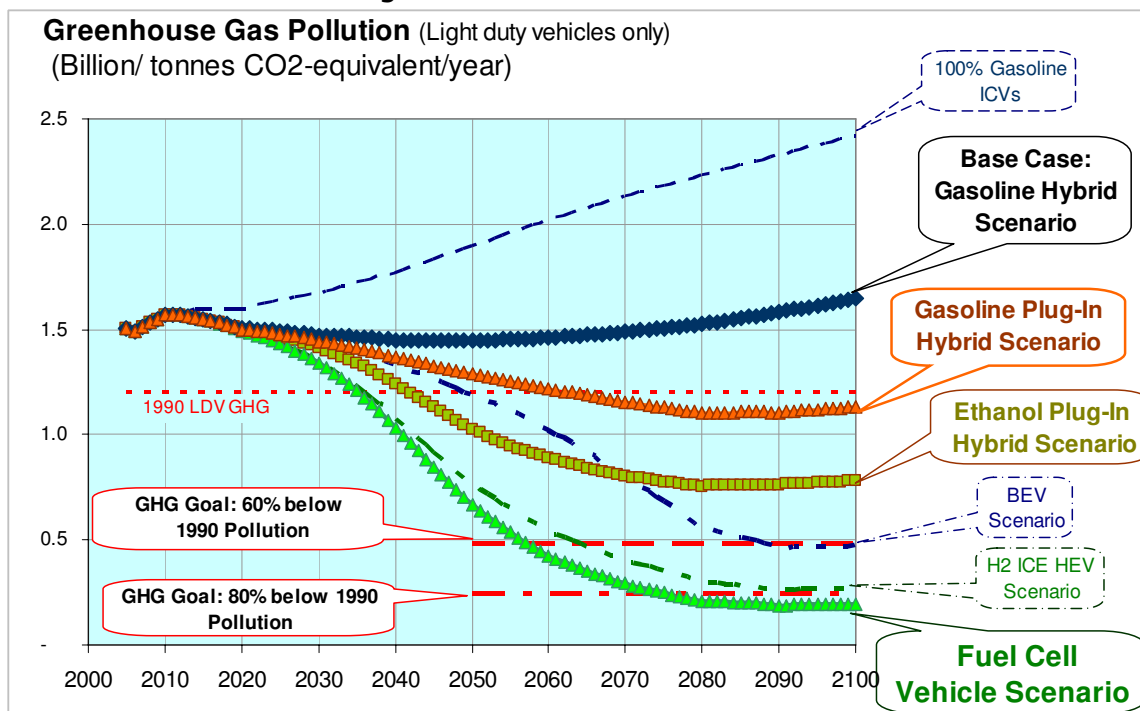

**Figure 1. Projected greenhouse gases for different alternative vehicle scenarios over the 21st century for the US light duty vehicle fleet, assuming that both the electrical grid and hydrogen production reduce their carbon footprints over time (BEV= battery electric vehicle; H<sub>2</sub> ICE HEV = hydrogen internal combustion engine hybrid electric vehicle)**

<sup>1</sup> C.E. Thomas, "Comparison of Transportation Options in a Carbon-Constrained World: Hydrogen, Plug-in Hybrids and Biofuels," the National Hydrogen Association Annual Meeting, Sacramento, California, March 31, 2008.

Similarly, Figure 2 shows that HEV's and PHEV's powered by biofuels could not reduce oil consumption in the US to levels that would allow us to produce most of our petroleum from American sources if needed in a crisis. To achieve oil "quasi-independence" and to cut GHGs to 80% below 1990 levels, we will have to eliminate the internal combustion engine from most light duty vehicles. We will have to transition to all-electric vehicles over the next few decades to meet our societal goals.

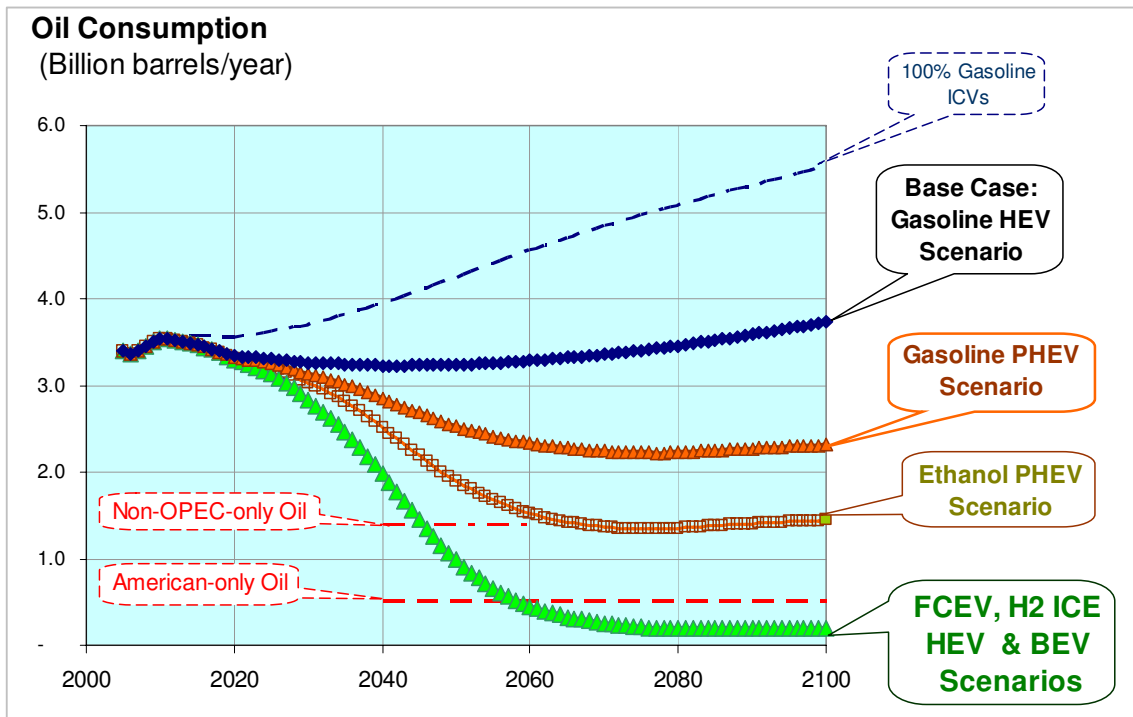

**Figure 2. Oil consumption from US light duty vehicles over the 21st century for different alternative vehicle scenarios**

We have but two choices to power all-electric vehicles: fuel cells or batteries. Both produce electricity to drive electric motors, eliminating the pollution and inefficiencies of the venerable internal combustion engine. Fuel cells derive their power from hydrogen stored on the vehicle, and batteries obtain their energy from the electrical grid. Both hydrogen and electricity can be made from low- or zero-carbon sources including renewable energy and nuclear energy.

## 2.0 Fuel Cell and Battery Comparisons

In the following sections, we compare hydrogen-powered fuel cell electric vehicles (FCEV's) with battery-powered electric vehicles (BEV's) in terms of weight, volume, greenhouse gases and cost.

## 2.1 Vehicle Weight

Figure 3 compares the specific energy (energy per unit weight) of current deep discharge lead-acid (Pb-A) batteries, nickel metal hydride (NiMH), Lithium-Ion and the US ABC (Advanced Battery Consortium) goal with the specific energy of a PEM fuel cell plus compressed hydrogen storage tanks. Two hydrogen pressures are shown: 5,000 psi and 10,000 psi with fiber-wrapped composite tanks. The 10,000 psi tanks weigh more than the 5,000 psi tanks due to the requirement for extra fiber wrap to provide the needed strength<sup>2</sup>.

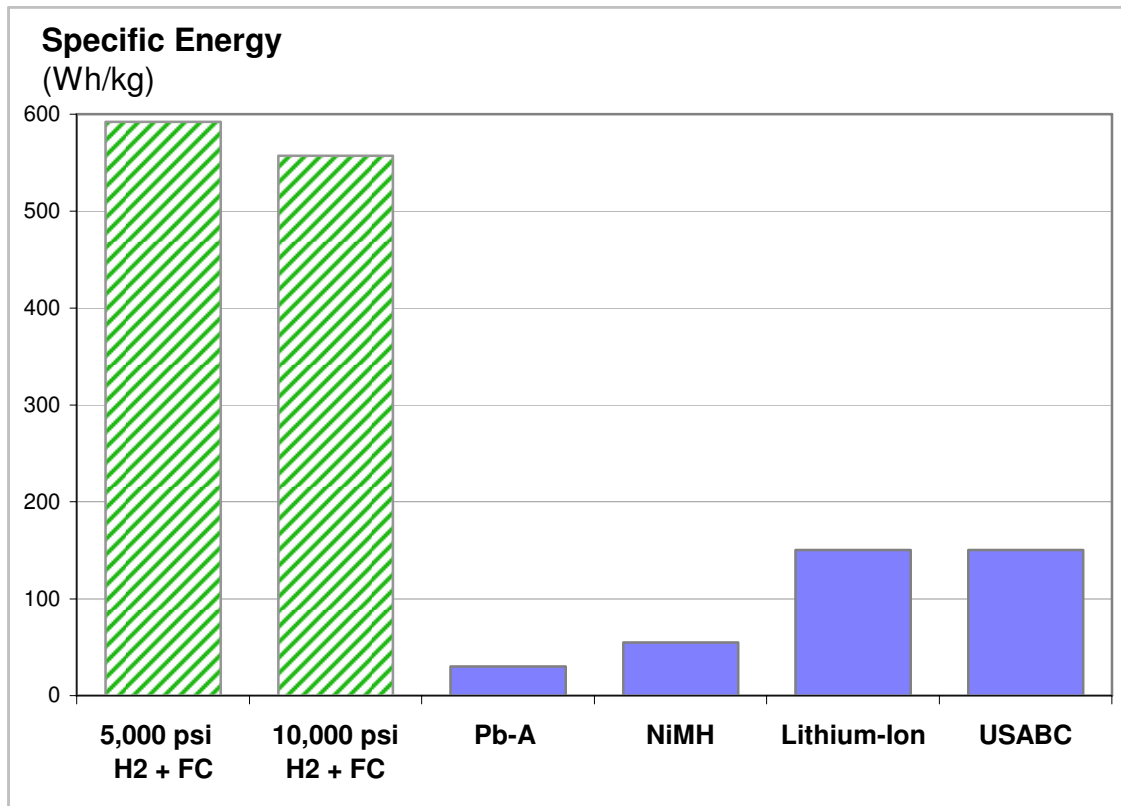

H2Gen: Wt\_Vol\_Cost.XLS; Tab 'Battery'; S58 - 3 / 25 / 2009

**Figure 3. The specific energy of hydrogen and fuel cell systems compared to the specific energy of various battery systems**

Compressed hydrogen and fuel cells can provide electricity to a vehicle traction motor with weights that are between eight to 14 times less than current

<sup>2</sup> The compressed hydrogen tanks and fuel cell data are based on the following parameters: fuel cell power of 60 kW, FC specific power of 0.94 kW/kg, FC power density of 1.6 kW/liter, 50% FC system efficiency averaged over EPA 1.5 times accelerated combined driving cycle, 4.5 kg of onboard hydrogen storage, carbon fiber performance factor of  $2.3 \times 10^6$  inches, tank performance factor of  $1.5 \times 10^6$  inches, 70% fiber content per weight, 100 pounds/square foot fiber density, and 2.25 safety factor on the hydrogen tank.

batteries, and four times less than the US ABC goal. As a result, EVs must be much heavier than FCVs for a given range, as shown in Figure 4. This chart is based on a 5-passenger Ford AIV (aluminum intensive vehicle) Sable with a FCEV test weight of 1280 kg, drag coefficient of 0.33, frontal area of 2.127 m<sup>2</sup>, and rolling resistance of 0.0092.

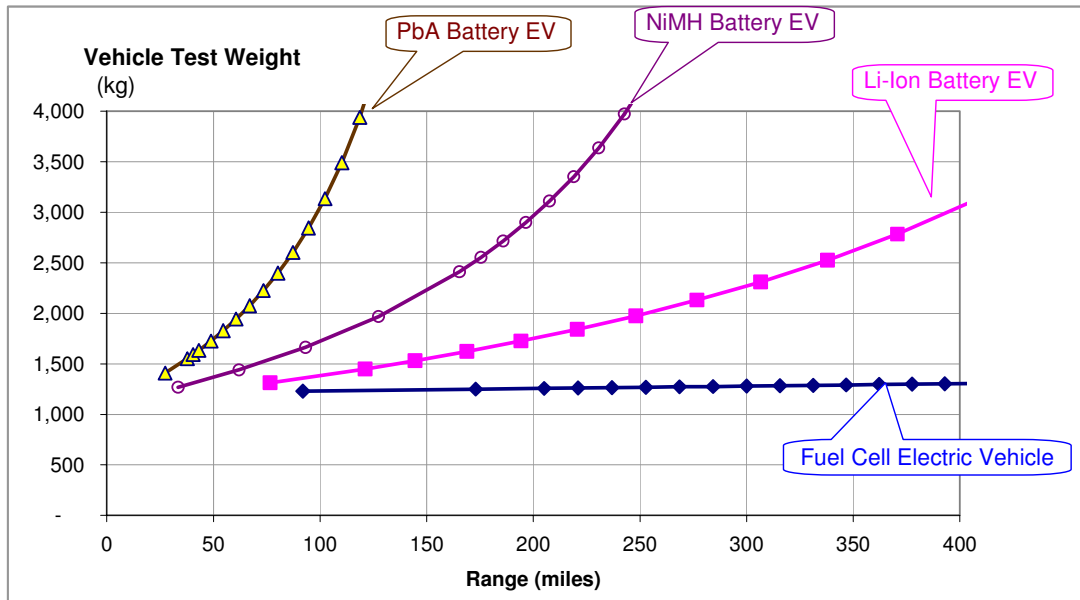

BPEV.XLS; 'Compound' AF142 3/25 /2009

**Figure 4. Calculated weight of fuel cell electric vehicles and battery electric vehicles as a function of the vehicle range**

As shown here, the extra weight to increase the range of the fuel cell EV is negligible, while the battery EV weight escalates dramatically for ranges greater than 100 to 150 miles due to weight compounding. Each extra kg of battery weight to increase range requires extra structural weight, heavier brakes, a larger traction motor, and in turn more batteries to carry around this extra mass, etc.

## 2.2 Storage Volume

Some analysts are concerned about the volume required for compressed gas hydrogen tanks. They do indeed take up more space than a gasoline tank, but compressed hydrogen tanks take up much *less* space (including the fuel cell system) than batteries for a given range. The basic energy density of the hydrogen fuel cell system in watt-hours per liter is compared with that of batteries in Figure 5.

The hydrogen system has an inherent advantage in basic energy density. But this advantage is amplified on a vehicle as a result of weight compounding. Thus the battery EV requires more stored energy per mile than the FCEV as a result of the heavier batteries and resulting heavier components. The net effect

## C. E. Thomas – Fuel Cell vs. Battery Electric Vehicles

on the volume required for the energy supply on the car is shown in Figure 6, again as a function of range. The space to store lead acid batteries would preclude a full five-passenger vehicle with a range of more than 150 miles, while the NiMH would be limited in practice to less than 200 to 250 miles range.<sup>3</sup>

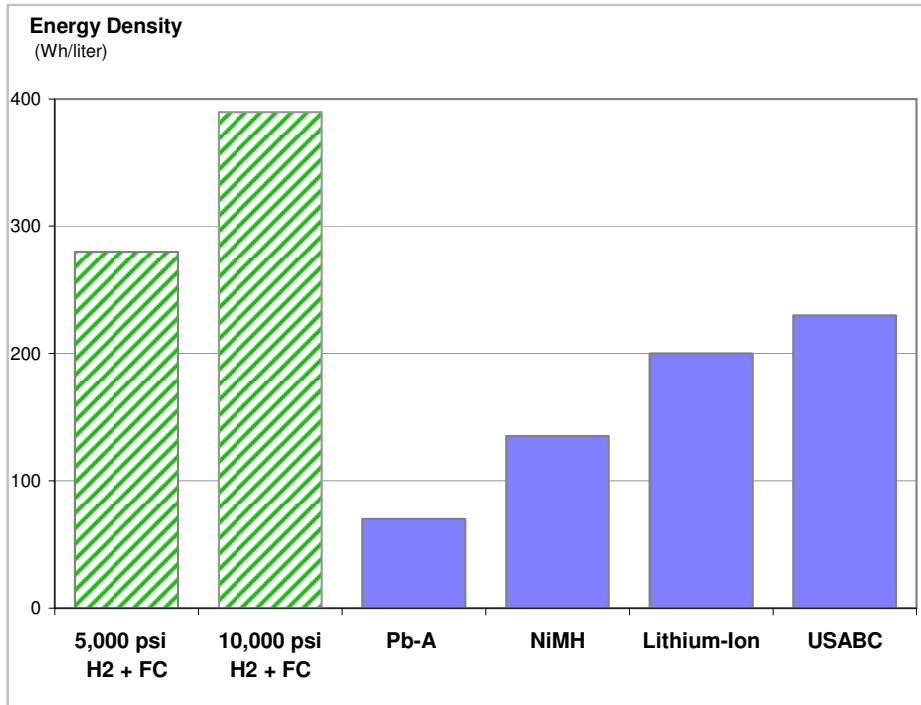

H2Gen: Wt\_Vol\_Cost.XLS; Tab 'Battery'; S34 - 3 / 25 / 2009

**Figure 5. Energy density of hydrogen tanks and fuel cell systems compared to the energy density of batteries**

An EV with an advanced Li-Ion battery could in principle achieve 250 to 300 miles range, but these batteries would take up 400 to 600 liters of space (equivalent to a 100 to 160 gallon gasoline tank!). The fuel cell plus hydrogen storage tanks would take up less than half this space, and, if the DOE hydrogen storage goals are achieved, then the hydrogen tanks would occupy only 100 liters (26 gallons) volume for 300 miles range.

<sup>3</sup> The battery EV range can be extended substantially by reducing its size, aerodynamic drag and rolling resistance as in the now defunct GM Impact/EV-1. But the FCEV range would also be increased with such an aerodynamic vehicle. Thus the relative comparisons between FCEVs and BEVs in these charts would still be valid.

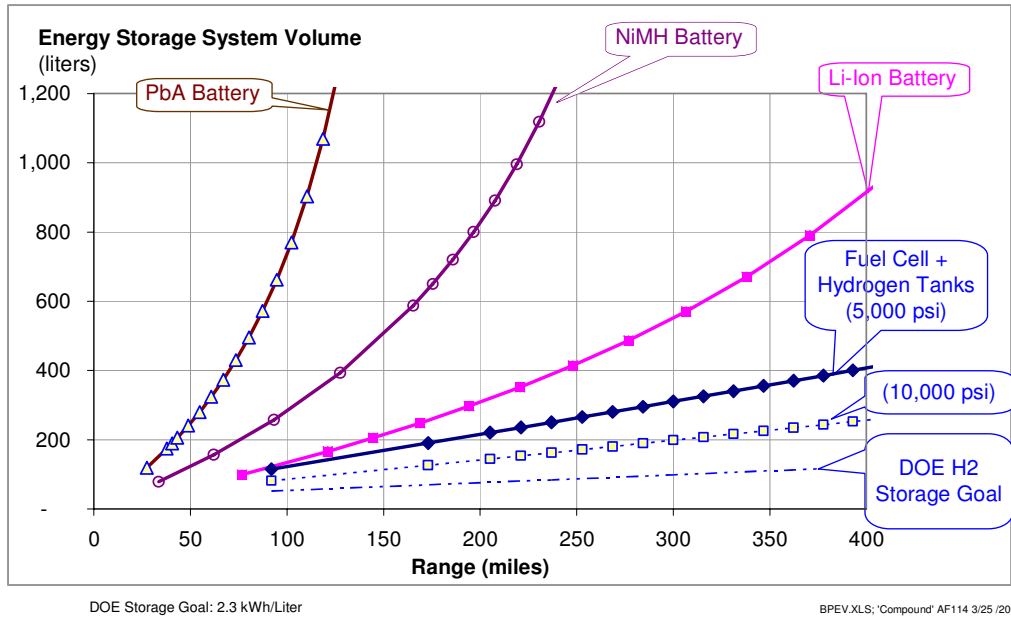

**Figure 6. Calculated volume of hydrogen storage plus the fuel cell system compared to the space required for batteries as a function of vehicle range**

### 2.3 Battery Performance Assumptions

The previous charts assume somewhat optimistic battery parameters for both specific energy and specific power. We placed star symbols on Figure 7 from Kromer and Heywood<sup>4</sup> of MIT to illustrate the energy and power ratings used in this model. In all cases we have assumed higher specific energy and power levels than existing capability for each battery technology. That is, the stars lie above the broad curves of existing performance for each battery. We have assumed in particular that the Li-ion battery technology achieves the BEV goal of 150 Wh/kg and 300 W/kg, well above current Li-ion battery system achievements. Note that Li-ion batteries have demonstrated 150 Wh/kg, but only at very low power levels. Similarly Li-ion batteries with very thin plates have achieved up to 800 W/kg specific power levels, but only at very low energy levels that would be totally unsuitable for a BEV.

These curves demonstrate that all battery technologies involve a trade-off between energy and power. For hybrid vehicles power is the major driver, since the onboard fuel provides stored energy via the internal combustion engine. An all-electric vehicle requires much more energy storage, which involves sacrificing specific power. In essence, high power requires thin battery electrodes for fast response, while high energy storage requires thick plates.

<sup>4</sup> Kromer, M.A., and J. B. Heywood, "Electric Powertrains: Opportunities and Challenges in the U.S. Light-Duty Vehicle Fleet," Sloan Automotive Laboratory, Massachusetts Institute of Technology, Publication No. LFEE 2007-03 RP, May 2007.

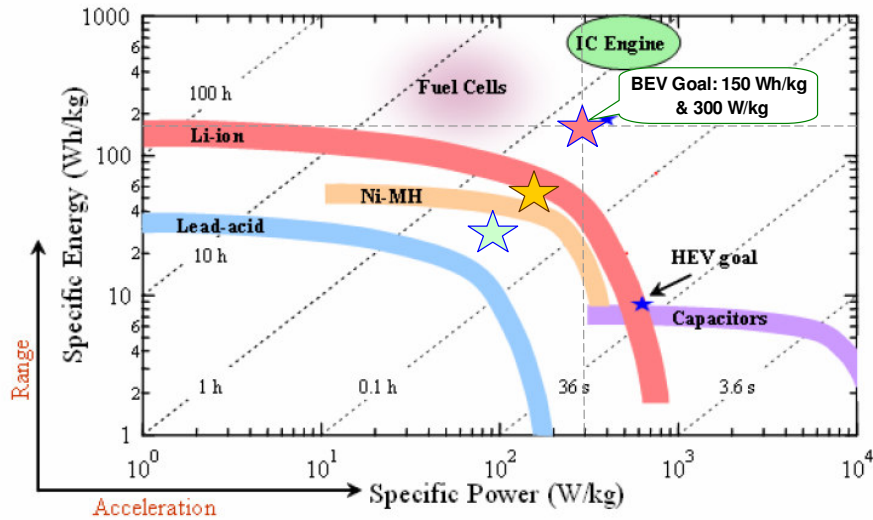

Figure 7. Specific Energy vs. Specific Power for battery technologies from Kromer and Heywood (MIT), May 2007; star symbols indicate the battery parameters used in this study that are all more optimistic than current battery performance

## 2.4 Greenhouse Gas Pollution

The greenhouse gas (GHG) implications of charging battery EVs with today’s power grid are serious<sup>5</sup>. Since on average 52% of our electricity in the US comes from coal, and since the grid efficiency is on the order of only 35%, GHGs would be much greater for EVs than for hydrogen-powered FCEVs, assuming that most hydrogen was made by reforming natural gas for the next decade or so.

The increased weight of the EV to achieve reasonable vehicle range increases fuel consumption as the vehicle becomes heavier. The impact on GHGs with today’s marginal grid mix is shown in Figure 8 below. Once again, the hydrogen FCEV running on hydrogen made from natural gas can achieve the 300 to 350 mile range demanded by American drivers without sacrificing GHG reductions. For frame of reference, the gasoline ICE version of the AIV Sable produces about 480 g/mile of CO<sub>2</sub>-equivalent emissions, so the hydrogen FCV would immediately cut GHG emissions by more than 50% compared to regular cars. This GHG calculation includes all “well-to-wheel” GHGs adjusted for a 100-year atmospheric lifetime.

<sup>5</sup> Of course if both the electricity to charge the car batteries and the hydrogen came from renewable sources, there would be no GHG implications. This GHG assessment applies to the decade or two before renewable or nuclear power (or coal with carbon capture and storage) replace most of the conventional coal-generated electricity.

From this analysis, a 5-passenger battery EV range would be limited to about 60 to 70 miles before that EV with lead acid batteries would generate more net GHGs than the gasoline version of the same car generating about 480 g/mile. The no-net-GHG increase range for a NiMH battery EV would be about 125 to 150 miles with these data, and an EV with advanced Li-Ion batteries would be limited to 250 miles range on a GHG limitation. Greater range is possible<sup>6</sup>, but only by generating more GHGs than current cars of the same size.

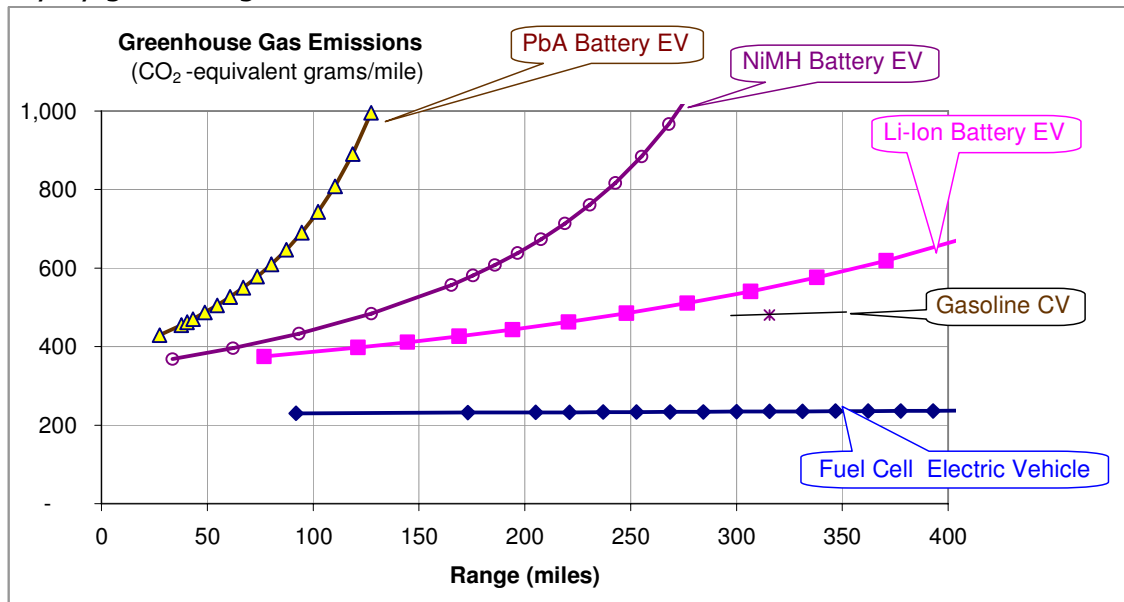

H2Gen: BPEV.XLS: WS 'Compound' AF169 3/25 /2009

**Figure 8. Well-to-wheels greenhouse gas emissions as a function of vehicle range for the average US marginal grid mix; all hydrogen is made from natural gas**

## 2.5 Cost

Kromer and Heywood at MIT have analyzed the likely costs of various alternative vehicles in mass production. They conclude that an advanced battery EV with 200 miles range would cost approximately \$10,200 more than a conventional car in 2030, whereas a FCEV with 350 miles range is projected to cost only \$3,600 more in mass production. Plug-in hybrid electric vehicles (PHEVs) with only 10 miles all-electric range would cost less than the FCEV as shown in Figure 9, but plug-in hybrids with 60 miles range are projected to cost over \$6,000 more than conventional gasoline cars. If we extrapolate the Kromer and Heywood data for BEVs to 300 miles range, then the BEV would cost approximately \$19,500 more than a conventional car.

<sup>6</sup> Assuming that the added weight, volume and cost of the battery banks were acceptable.



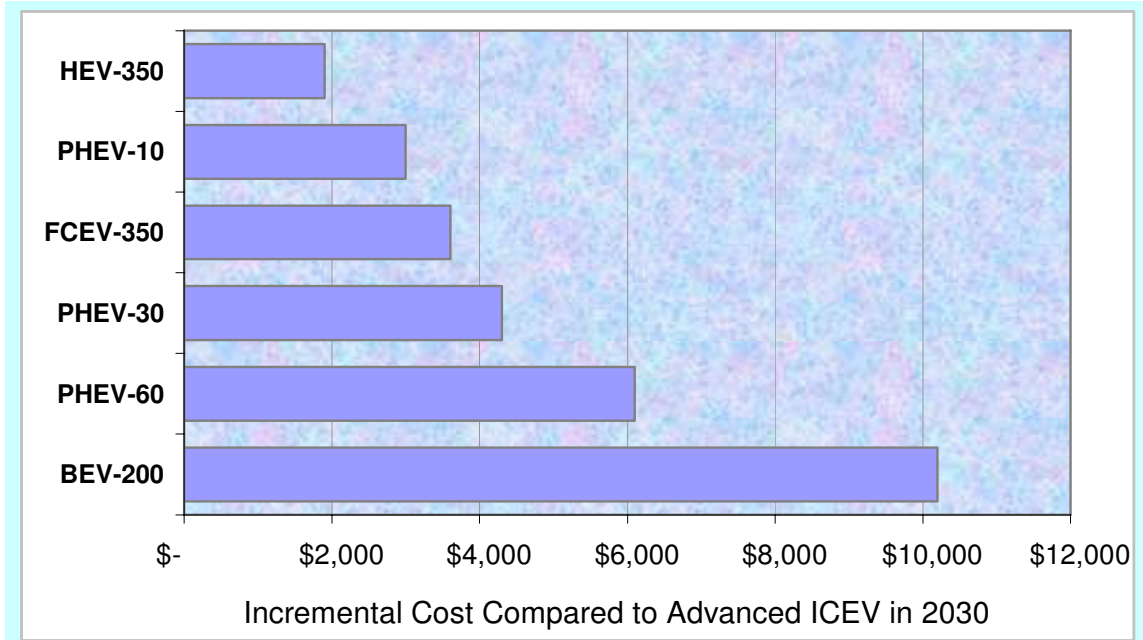

Ref: Kromer & Heywood, "Electric Powertrains: Opportunities & Challenges in the U.S. Light-Duty Vehicle Fleet Report # LFEE 2007-03RP, MIT, May, 2007, Table 53 Story Simultaneous.XLS; Tab 'AFV Cost'; N 26 3/25/2009

HEV-350 = hybrid electric vehicle with 350 miles range; PHEV-10 = plug-in hybrid electric vehicle with 10 miles all-electric range; FCEV-350 = fuel cell electric vehicle with 350 miles range on hydrogen; PHEV-30 = plug-in with 30 miles electric range; PHEV-60 = plug-in with 60 miles electric range; BEV-200 = battery powered electric vehicle with 200 miles range

**Figure 9. Estimated mass production incremental cost of hybrid and electrical vehicles compared to a conventional gasoline internal combustion engine vehicle in the 2030 time frame**

We conclude that the fuel cell electric vehicle could provide the range, passenger and trunk space and refueling times demanded by modern drivers for full-function vehicles. All-electric battery-powered electric vehicles will probably find niche applications as city cars and limited range commuter cars. A major breakthrough in battery technology, well beyond the US ABC battery goals, would be required before a battery EV could satisfy customer’s needs for conventional passenger cars, particularly with respect to battery recharging times. Most drivers would not accept more than 15 to 20 minutes charging time on long distance travel for EVs, while FCEVs can be refueled in the 5 to 10 minutes expected by consumers.

### 3.0 Well-to-Wheels Efficiency

Some analysts have concluded that fuel cell electric vehicles are less efficient than battery electric vehicles since the fuel cell system efficiency over a driving cycle might be only 52%, whereas the round-trip efficiency of a battery might be 80%. However, this neglects the effects of extra vehicle weight on fuel economy. Since battery EVs are heavier than fuel cell EVs for any given range, the BEV will require more energy per mile driven.

## C. E. Thomas – Fuel Cell vs. Battery Electric Vehicles

In other words, we need to estimate the total “well-to-wheels” efficiency of the vehicle, not just the efficiency of any one component acting in isolation. For example, suppose we have one million btu’s of natural gas. What is more efficient: to convert that natural gas to electricity to drive a battery EV, or to convert that natural gas to hydrogen to run a fuel cell electric vehicle?

Figure 10 illustrates the answer: one would need to burn approximately 1.77 million btu’s (MBTU) of natural gas in a combustion turbine generate the electricity to power a battery EV for 300 miles on the EPA’s 1.25X accelerated combined driving cycle. For a more efficient combined cycle gas turbine generator system, 1.18 MBTU’s of natural gas would be required. But only 0.81 MBTU’s of natural gas would be required to generate enough hydrogen to power a fuel cell EV for 300 miles. On a full-cycle well-to-wheels basis, then, **the hydrogen-powered fuel cell electric vehicle is between 1.5 to 2.2 times more energy efficient than a battery EV** in converting natural gas to vehicle fuel.

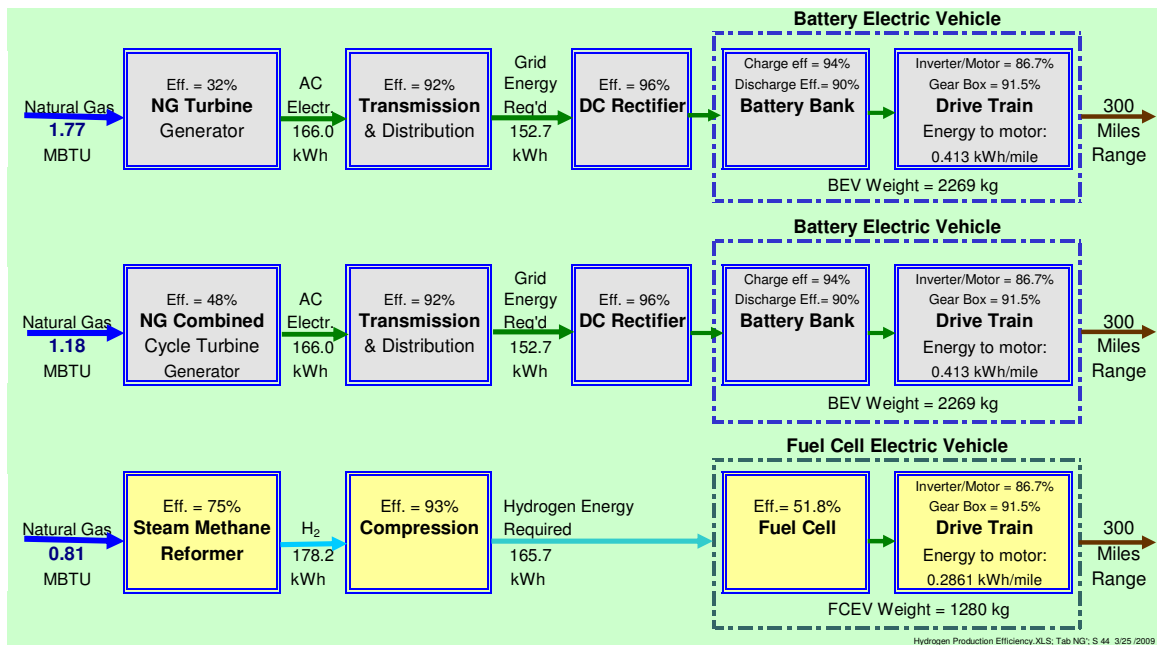
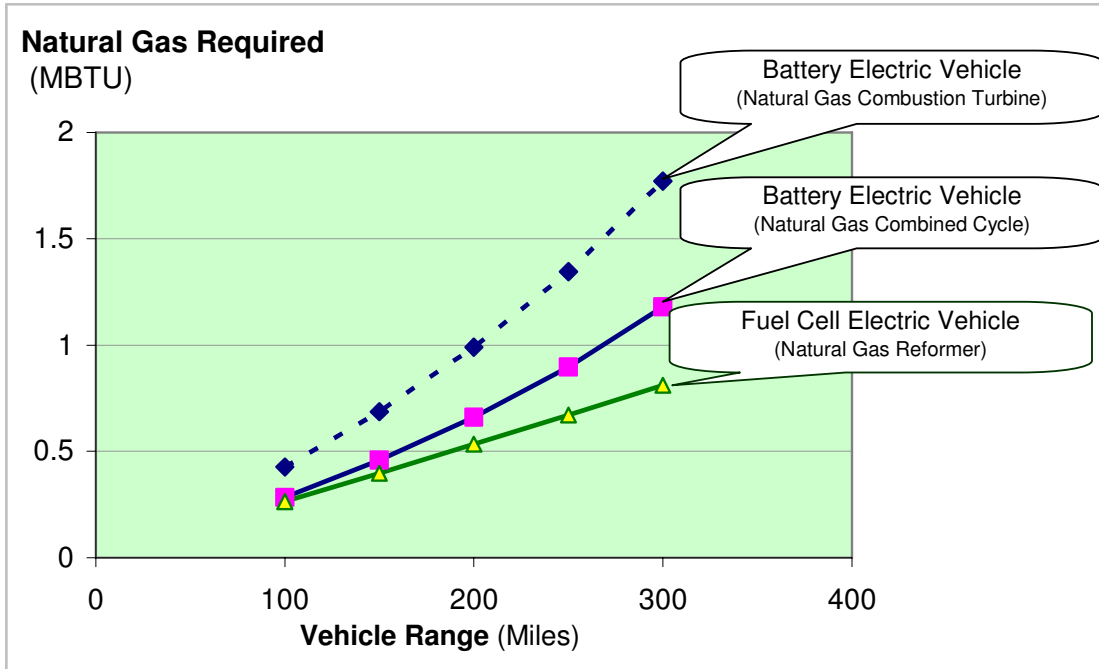

Figure 10. Comparison of the amount of natural gas required to propel a battery EV 300 miles compared to a fuel cell EV traveling 300 miles

In effect, the increased weight of a long range battery EV, even assuming advanced Li-ion battery systems, almost eliminates the improved round-trip efficiency of the battery pack compared to the fuel cell system. Note that the heavy battery EV (2,269 kg) requires almost as much energy (152.7 kWh) as the fuel cell EV (165.7 kWh) to travel 300 miles. This advantage diminishes at shorter range as the battery EV becomes lighter. As shown in Figure 11, the

efficiency of a battery EV with only 100 miles range is almost identical to the total system efficiency of a fuel cell EV, assuming that the electricity is generated by a modern combined cycle turbine with 48% total system efficiency.



Hydrogen Production Efficiency.XLS; Tab NG per mile; AM 38 3/25 /2009

Figure 11. Quantity of natural gas required to power an advanced Li-ion battery EV compared to a hydrogen-powered fuel cell EV as a function of vehicle range

#### 4.0 Conclusions

The fuel cell EV is superior to the advanced Li-ion battery full function EV on six major counts; the fuel cell EV:

- Weighs less
- Takes up less space on the vehicle
- Generates less greenhouse gases
- Costs less
- Requires less well-to-wheels energy
- Takes less time to refuel

These advantages are dominant if the battery EV must have 300 miles range to serve as a fully functional all-purpose vehicle, but the fuel cell EV also has superior attributes for EVs with only 200 miles range as summarized in Table 1. These advantages are also plotted in Figure 12 as the ratio of the battery EV value to the fuel cell EV value for each attribute. The advanced battery EV has

## C. E. Thomas – Fuel Cell vs. Battery Electric Vehicles

over twice the volume, greenhouse gas emissions and cost as the fuel cell EV, and over 50% more weight and energy requirements to travel 200 to 300 miles.

These advantages explain why nearly all major automobile companies dropped their pure battery electric vehicle developments in the 1990's and devoted most of their efforts to the fuel cell EV. While the car companies are now considering plug-in hybrids that do not require as overwhelming battery requirements as the all-electric EV, and while some car companies are developing short range city cars for niche markets, the underlying benefits of the fuel cell have not changed. We fully expect that the fuel cell EV will eventually dominate the transportation market.

**Table 1. Summary of fuel cell EV attributes compared to those of the advanced battery EV for 200-mile and 300-mile range**

	300 miles Range			200 miles Range		
	Fuel Cell EV	Battery EV	Ratio BEV/FCEV	Fuel Cell EV	Battery EV	Ratio BEV/FCEV
Vehicle Weight (kg)	1280	2270	1.77	1256	1750	1.39
Storage Volume (Liters)	100	560	5.60	75	300	4.00
	310	560	1.81	215	300	1.40
Greenhouse Gases (g/mile)	234	535	2.29	232	445	1.92
Incremental Cost (\$)	3,600	19,500	5.42	2,830	10,200	3.60
Natural Gas Req'd (MBTU)	0.81	1.18	1.46	0.53	0.66	1.25
	0.81	1.77	2.19	0.53	0.99	1.87

Story Simultaneous.XLS; Tab 'AFV Cost'; N 63 3/25 /2009

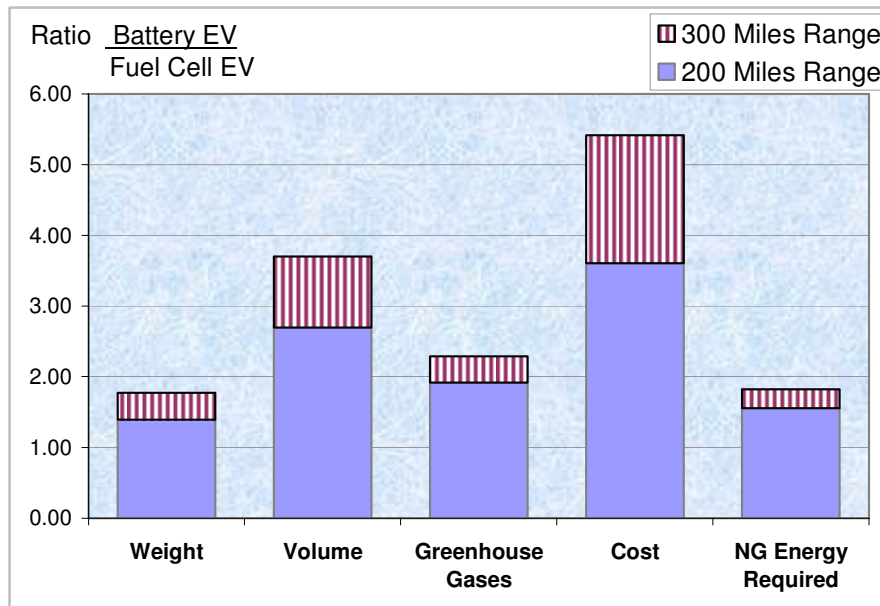

Story Simultaneous.XLS; Tab 'AFV Cost'; N 87 3/25 /2009

**Figure 12. Ratio of advanced battery EV attribute to fuel cell EV attribute for both 200 and 300 miles range**